



SALGUEDA

INSERTS / HOGARES / CHIMENEAS / ESTUFAS



www.salgueda.com



T A G A

ref. E373-PS
ref. E376-PS



- Chimenea de leña con hogar de fundición.
- Opción con turbinas (E-376-PS)
- Sistema telescópico: Altura regulable desde 2,40 a 2,70 m
- Salida tubo superior de 180 mm.
- Potencia nominal 12 Kw
- Pintura Senotherm.

CE 12 Kw.

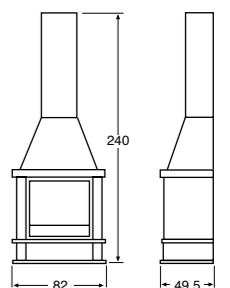



DANA

ref. E379-PS
ref. E372-PS



- Versión turbo con insert 700 3 cristales (ref. E379-PS).
- Versión con hogar 700 3 cristales (ref. E372-PS).
- Con pintura senotherm.
- Altura regulable mediante sistema telescópico de 2,45 a 2,70 m.
- Conforme a la norma UNE EN13229.

También en versión lateral:

- Versión turbo derecha o izquierda (E379D / E379I).
- Versión hogar derecha o izquierda (372D/E372I).

 14 Kw.

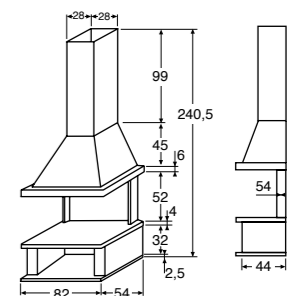



TIGRIS

ref. E355-PS
ref. E348-PS
ref. E385-PS



- Versión con insert 700 GV (ref. E355-PS).
- Versión con hogar E055-H (ref. E348-PS).
- Versión con Insert 800 GV (ref. E385-PS).
- Con pintura senotherm.
- Altura regulable mediante sistema telescópico de 2,45 a 2,70 m.
- Conforme a la norma UNE EN13229.

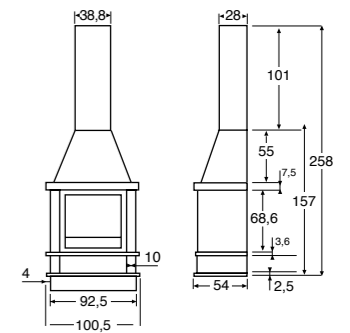

CE 14 Kw.

DALÍ

ref. E375-PS
ref. E378-PS



- Versión con insert 700 GV (ref. E375).
- Versión con hogar 700 GV (ref. E378).
- Con pintura senotherm.
- Altura regulable mediante sistema telescópico de 2,45 a 2,70 m.
- Conforme a la norma UNE EN13229.

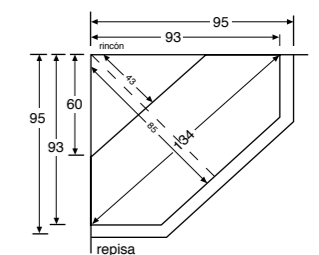

CE 14 Kw.



RUBI HORN O

ref. E045



- Íntegramente en fundición.
- Cristal vitrocerámico.
- Salida posterior.
- Conforme a la norma UNE EN13240.

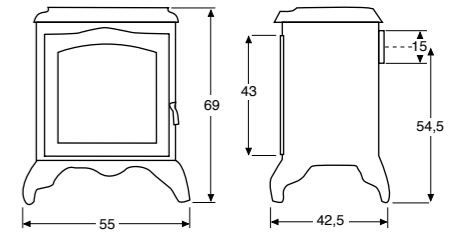

CE  100 Kg.  10 Kw.  150 mm

NEREA

ref. E046



- Íntegramente en fundición.
- Cristal vitrocerámico.
- Salida superior o posterior.
- Conforme a la norma UNE EN13240.

 150 mm

 130 Kg.

 12 Kw.

CE

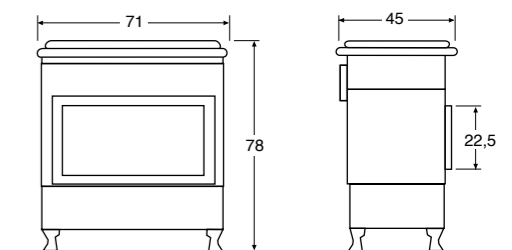



ATHIRA 700 GV

ref. AT055



- Fundición y acero.
- Sistema cristal limpio.
- Termostato de seguridad.
- Ventiladores con dos velocidades.
- Cristal vitrocerámico.
- Incluye Insert E055.
- Conforme a la norma UNE EN13240.

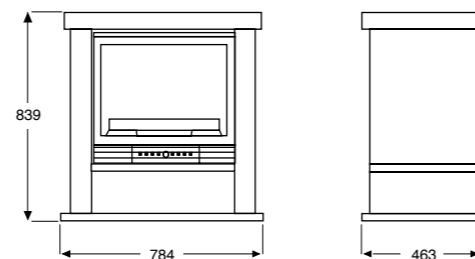

CE  160 Kg.  14 Kw.

ATHIRA 800 GV

ref. AT063



- Fundición y acero.
- Sistema cristal limpio regulable.
- Termostato de seguridad.
- Ventiladores con dos velocidades.
- Cristal vitrocerámico.
- Incluye Insert E063.
- Conforme a la norma UNE EN13240.

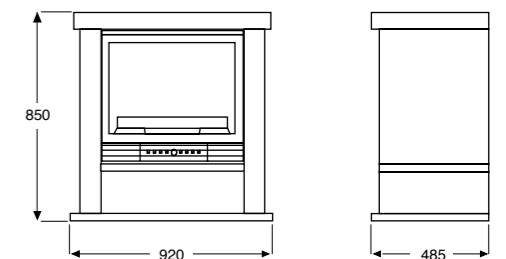

CE  180 Kg.  18 Kw.



ATHIRA 700 2P

ref. AT051



- Fundición y acero.
- Sistema cristal limpio.
- Termostato de seguridad.
- Ventiladores con dos velocidades.
- Cristal vitrocerámico.
- Incluye Insert E051.
- Conforme a la norma UNE EN13240.

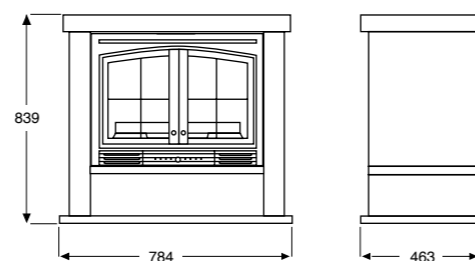

CE  160 Kg.  14 Kw.

ATHIRA 800 2P

ref. AT061



- Fundición y acero.
- Sistema cristal limpio regulable.
- Termostato de seguridad.
- Ventiladores con dos velocidades.
- Cristal vitrocerámico.
- Incluye Insert E061.
- Conforme a la norma UNE EN13240.

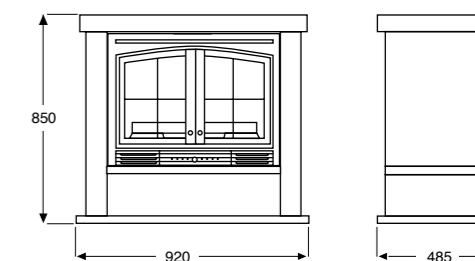

CE  180 Kg.  18 Kw.



ATHIRAS COLOR

ref. AT760-N

OTROS COLORES DISPONIBLES:

ref. AT760-R

ref. AT760-B



- Fundición y acero.
- Sistema cristal limpio.
- Termostato de seguridad.
- Ventiladores con dos velocidades.
- Cristal vitrocerámico.
- Incluye Insert E760.
- Conforme a la norma UNE EN13240.

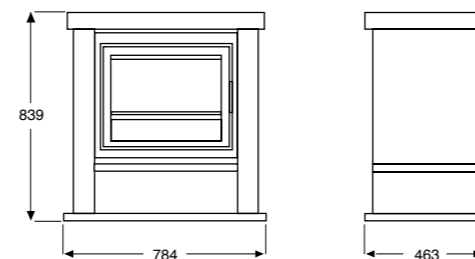

CE  160 Kg.  14 Kw.



ATHIRA 650 TURBO

ref. E141



- Opción sin turbinas (ref. E140)
- Fundición y acero.
- Sistema cristal limpio regulable.
- Termostato de seguridad.
- Ventiladores con dos velocidades.
- Cristal vitrocerámico.
- Conforme a la norma UNE EN13240.

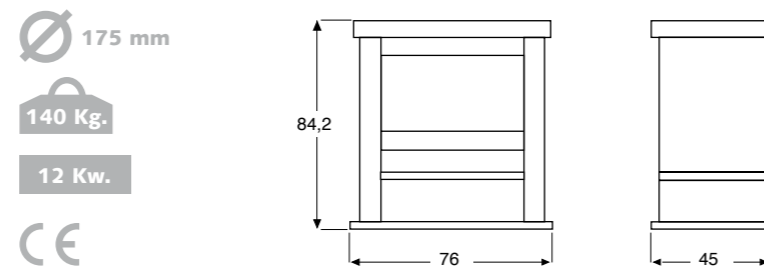

PARRILLAS



MANGOS:

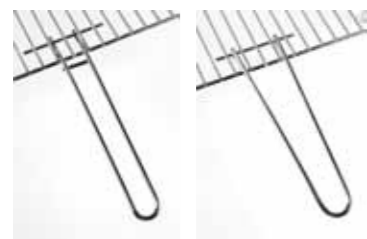

- Parrillas de acero con baño cromado.
- Mango extraíble.

PARRILLA SIN PATAS:

A3: 29,5x56cm

A4: 35x66cm

PARRILLA CON PATAS:

A5: 28x46cm

A6: 30x65cm

